

STATIC DIMENSIONS

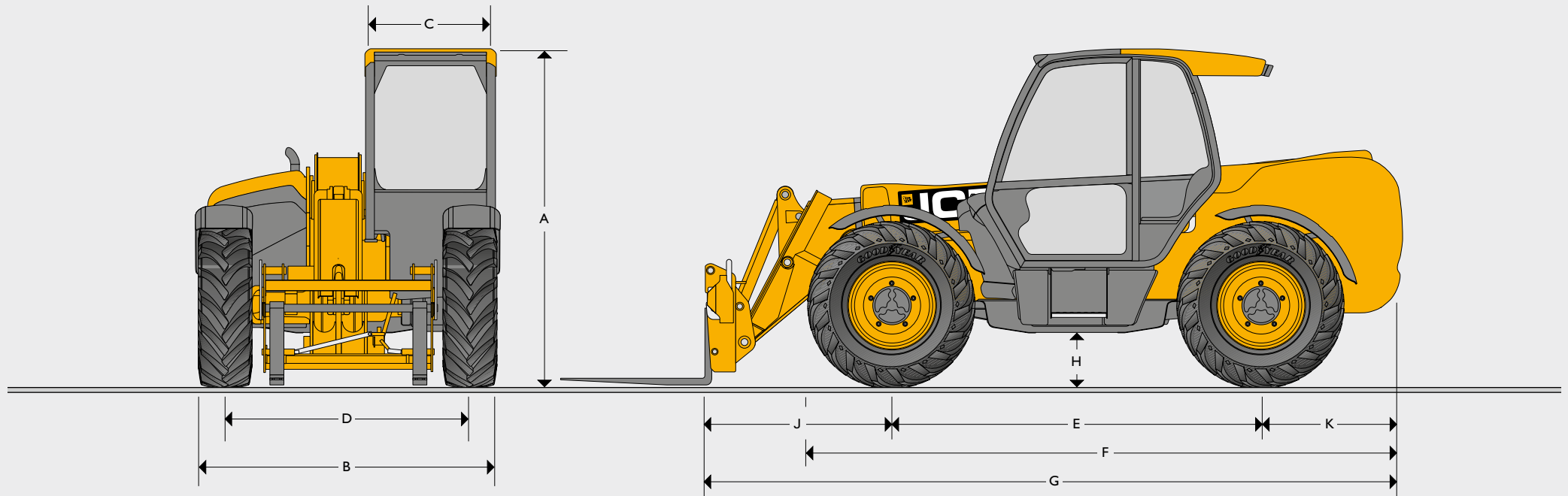

STATIC DIMENSIONS

Machine model		531-70	541-70	535-95	533-105	535-125 HiViz	540-140 HiViz	540-170	540-180 HiViz	540-200
A Overall height	m	2.49	2.49	2.49	2.49	2.59	2.59	2.69	2.59	2.72
B Overall width (over tyres)*	m	2.23	2.23	2.36	2.36	2.35	2.35	2.44	2.35	2.44
C Inside width of cab	m	0.94	0.94	0.94	0.94	0.94	0.94	0.94	0.94	0.94
D Front track	m	1.81	1.81	1.87	1.87	1.90	1.90	1.90	1.90	1.97
E Wheelbase	m	2.75	2.75	2.75	2.75	2.75	2.75	2.75	2.75	2.75
F Overall length to front tyres	m	4.38	4.38	4.38	4.38	4.74	4.74	5.08	4.75	5.09
G Overall length to front carriage	m	4.99	4.99	4.99	5.38	5.80	6.23	6.36	6.27	6.81
H Ground clearance	m	0.40	0.40	0.40	0.40	0.40	0.40	0.40	0.40	0.41
J Front wheel centre to carriage	m	1.25	1.25	1.20	1.62	1.68	2.11	1.94	2.15	2.39
K Rear wheel centre to rear face	m	0.99	0.99	1.04	1.01	1.37	1.37	1.67	1.37	1.67
Overall width with stabilisers fully deployed	m	NA	NA	NA	2.63	2.57	2.57	3.55	3.39	3.82
Outside turn radius (over tyres)	m	3.7	3.7	3.7	3.7	3.75	3.75	4.10	3.75	4.1
Carriage rollback angle	degrees	42.6	42.6	41.0	41.2	37.0	37.0	39	36.50	39
Carriage dump angle	degrees	37.5	37.5	24.0	24.0	12.5	12.5	8.8	12.50	8.8
Weight	kg	7060	7850	8215	8850	10066	10880	12060	11380	12985
Tyres		15.5/80-24	15.5/80-24	15.5/80-24	15.5/80-24	15.5/80-24	15.5/80-24	15.5/80-24	15.5-25	17.5-25

* Type dependent

LIFT PERFORMANCE

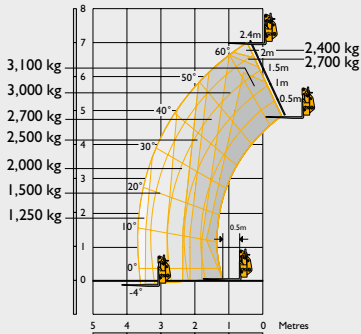
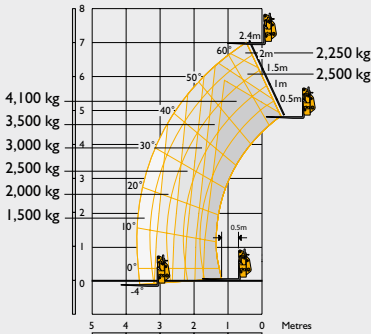
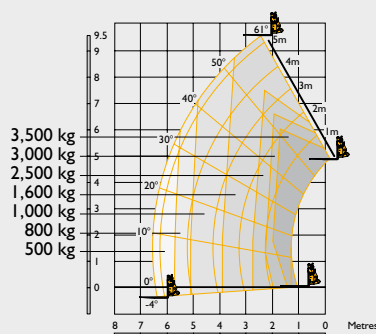
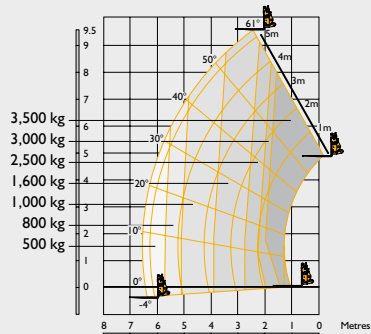
		531-70	541-70	535-95	535-95 Sway
					
Maximum lift capacity	kg	3100	4100	3500	3500
Lift capacity to full height	kg	2400	2250	1600	1600
Lift capacity at full reach	kg	1250	1500	500	500
Lift height	m	7.0	7.0	9.50	9.50
Reach at maximum lift height	m	0.54	0.54	2.49	2.49
Maximum forward reach	m	3.7	3.7	6.52	6.52
Reach with 1 tonne load	m	3.7	3.7	5.08	5.08
Placing height	m	6.3	6.3	8.78	8.78

Complies with stability test EN 1459 Annex B. Chassis Levelling (Sway) with stabilisers retracted (Sway angle ±9°).

LIFT PERFORMANCE

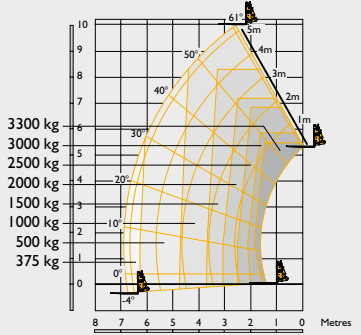
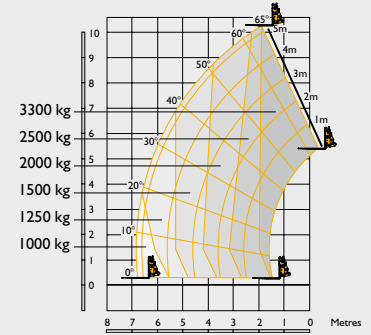
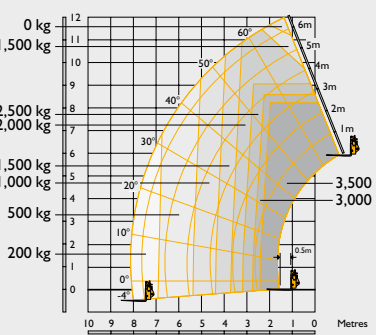
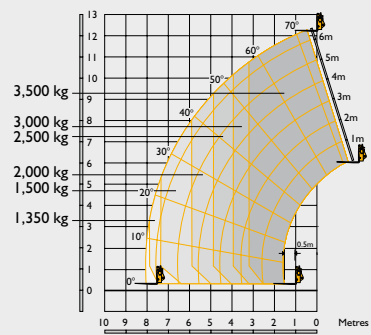
		533-105 Stabilisers retracted	533-105 Stabilisers extended	535-125 HiViz Stabilisers retracted Sway	535-125 HiViz Stabilisers extended Sway
					
Maximum lift capacity	kg	3300	3300	3500	3500
Lift capacity to full height	kg	1000	2500	1500	3500
Lift capacity at full reach	kg	375	1000	200	1350
Lift height	m	10.22	10.22	11.6	12.27
Reach at maximum lift height	m	2.69	1.99	2.01	0.54
Maximum forward reach	m	6.83	6.83	8.06	8.06
Reach with 1 tonne load	m	6.83	6.83	5.31	8.06
Placing height	m	9.44	9.82	11	11.75

Complies with stability test EN 1459 Annex B. Chassis Levelling (Sway) with stabilisers retracted (Sway angle ±9°).

LIFT PERFORMANCE

540-140 HiViz Stabilisers retracted Sway

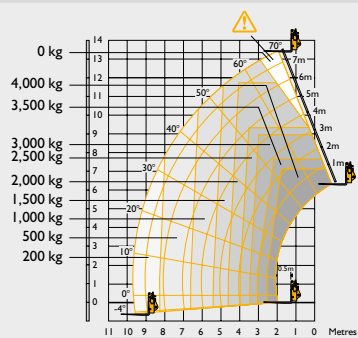

540-140 HiViz Stabilisers extended Sway

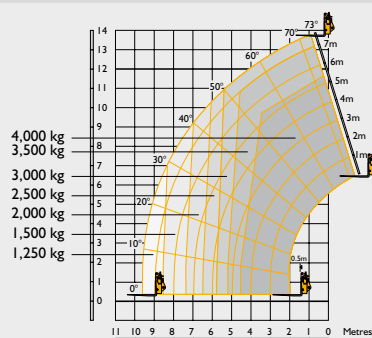

540-170 Stabilisers retracted Sway

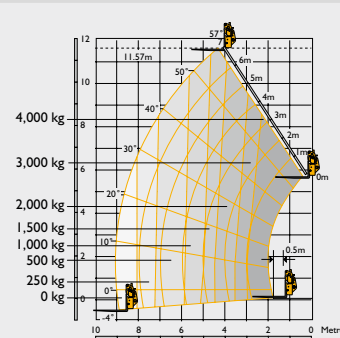

540-170 Stabilisers extended Sway

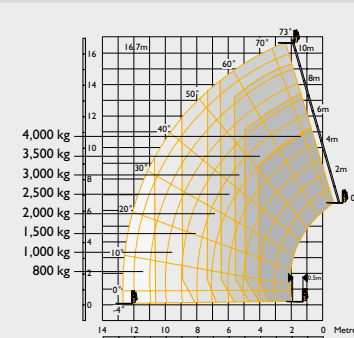

Maximum lift capacity	kg	4000	4000	4000	4000
Lift capacity to full height	kg	1500	3000	1500	2500
Lift capacity at full reach	kg	200	1250	0	800
Lift height	m	12.89	13.78	11.57	16.7
Reach at maximum lift height	m	3.09	1.01	4.32	1.97
Maximum forward reach	m	9.70	9.64	9.04	12.50
Reach with 1 tonne load	m	6.61	9.64	5.76	11.70
Placing height	m	12.40	13.30	10.90	16.20

Complies with stability test EN 1459 Annex B. Chassis Levelling (Sway) with stabilisers retracted (Sway angle $\pm 9^\circ$).

LIFT PERFORMANCE

540-180 HiViz Stabilisers retracted Sway

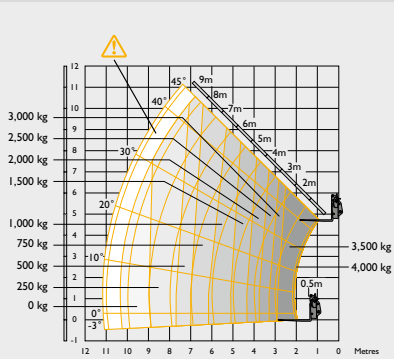

540-180 HiViz Stabilisers extended Sway

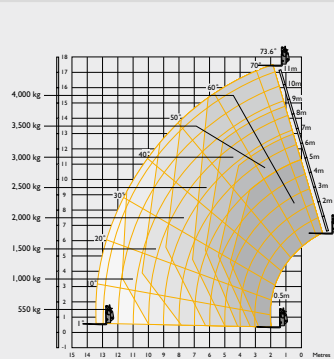

540-200 Stabilisers retracted Sway

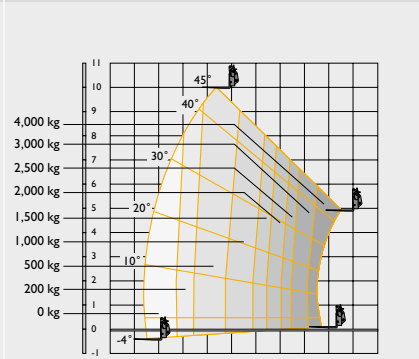

540-200 Stabilisers extended Sway

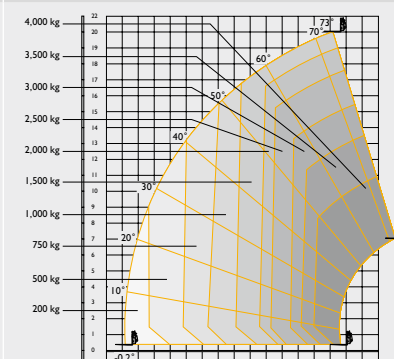

Maximum lift capacity	kg	4000	4000	4000	4000
Lift capacity to full height	kg	500	2500	500	1500
Lift capacity at full reach	kg	0	550	0	200
Lift height	m	10.69	17.51	10.27	20
Reach at maximum lift height	m	6.92	1.88	6.42	2.82
Maximum forward reach	m	10.47	13.34	9.63	15.9
Reach with 1 tonne load	m	6.25	11.72	6.25	10.65
Placing height	m	10.0	17.0	9.1	19.1

Complies with stability test EN 1459 Annex B. Chassis Levelling (Sway) with stabilisers retracted (Sway angle $\pm 9^\circ$).

LIFT PERFORMANCE

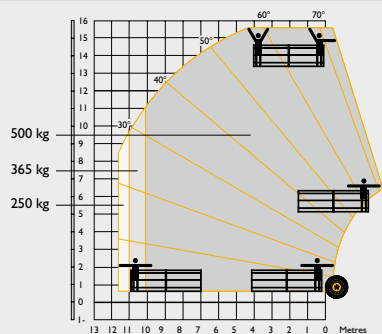
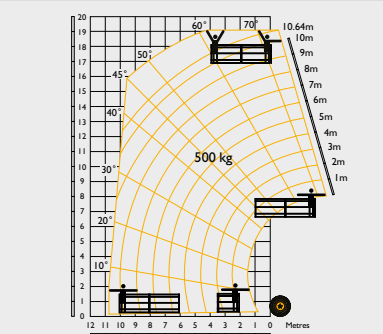
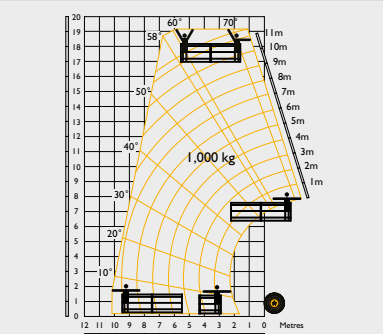
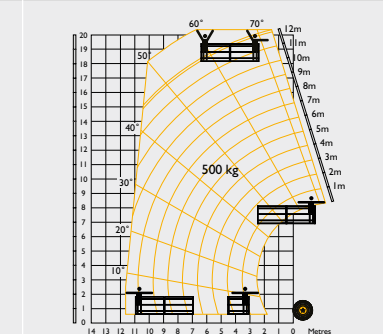
		540-140 HiViz Man platform Stabilisers extended	540-170 HiViz Man platform Stabilisers extended	540-180 HiViz Man platform Stabilisers extended			540-200 HiViz Man platform Stabilisers extended
							
				365kg basket	500kg basket	1000kg basket	
Machine capacity	kg	4000	4000	4000	4000	4000	4000
Personnel work height	m	15.6	19.09	19.25	19.25	19.25	20.3
Personnel work reach at maximum reach	m	11.75	11.75	13.16	12.17	10.18	11.63
Platform rated capacity	kg	500	500	365	500	1000	500
Capacity at full reach	kg	365	500 @ 10.78m	365 @ 13.16m	500 @ 12.17m	1000 @ 10.18m	500 @ 11.63m
Maximum forward reach (slewed platform)	m	11.14	10	12.5	11.5	10.18m	11.12
Capacity to full working height	kg	500	500	365	500	1000	500

POINT LOADS

At maximum machine lift capacity (i.e. 4 tonne on a 540-170)										
		531-70	541-70	535-95	533-105	535-125 HiViz	540-140 HiViz	540-170	540-180 HiViz	540-200
Load per front wheel	kg	4731	5616	5540	5565	6365	6880	7541	6560	7723
Load per rear wheel	kg	441	480	440	476	415	415	610	1131	730
Load per stabiliser	kg	N/A	N/A	N/A	4188	5151	6010	5824	6243	5760
With no load on the forks and boom retracted in travel position										
Load per front wheel	kg	1803	1847	1957	2312	2499	2484	2694	2608	2992
Load per rear wheel	kg	1819	2200	2273	2078	2530	3060	3457	3462	3462

ENGINE

JCB 430 Dieselmix Stage V 3ltrs 4 cylinder, aspiration turbo charged.

	531-70	541-70	535-95	533-105	535-125 HiViz	540-140 HiViz	540-170	540-180 HiViz	540-200
Engine 55kW (75hp) @ 2200rpm, 440Nm torque at 1300rpm	Standard	Standard	Standard	Standard	Standard	Standard	Option	Standard	Standard

JCB EcoMAX T4 Final, Capacity 4 cylinder 4.4ltrs, Aspiration turbocharged cooled.

	531-70	541-70	535-95	533-105	535-125 HiViz	540-140 HiViz	540-170	540-180 HiViz	540-200
Engine 81kW (109hp) @ 2200rpm, 512Nm torque at 1300rpm	Option	Option	Option	Option	Option	Option	Standard	N/A	Option
Engine 93kW (125hp) @ 2200rpm, 550Nm torque at 1300rpm	Option	Option	Option	Option	Option	Option	Option	N/A	Option

HYDRAULIC CYCLE TIMES

	531-70	541-70	535-95	533-105	535-125 HiViz	540-140 HiViz	540-170	540-180 HiViz	540-200
Boom raise s	7.2	8.8	9.1	8.8	10.4	13.5	22.7	13.8	17.3
Boom lower s	5.4	6.5	7.7	8.5	8.1	11	23.4	10.2	15.9
Extend s	6.8	6.8	10.5	13.2	15.7	15.6	18.3	22.4	28.1
Retract s	5	5	11.2	13.6	12.8	14.4	16.7	17.9	22.7
Bucket dump s	3.5	3.5	2.4	2.4	1.8	1.7	4.2	2.9	6.1
Bucket crowd s	2.9	2.9	3.5	3.4	2.3	2.0	4.6	2.6	5.9

HYDRAULICS

	Hydraulic System Pressure (bar)	Max. Pump flow (litres)
531-70	241	82
541-70	260	82
535-95	241	82
533-105	241	82
535-125	260	110
540-140	260	110
540-170	260	170
540-180	260	103
540-200	260	110

NOISE AND VIBRATION

	55kW	81kW	93kW	Uncertainty	Measurement conditions.
Noise at the operator station LpA	77	80	81	+/- 1 dB	Determined in accordance with the test method defined in EN12053.
Noise emission from the machine LWA	104	106	107	+/- 1 dB	Guaranteed equivalent sound power (external noise) determined in accordance with the dynamic test conditions defined in 2000/14/EC.
Hand-arm vibration m/s ²	<2.5	<2.5	<2.5	N/A	ISO 5349-2:2001 dynamic test conditions.

TRANSMISSION

Torque converter, 4 speed powershift gearbox.

Travel speed 531-70/541-70/535-95/533-105: 29kph, 33kph (when 2/4WD select is specified).

Travel speed 535-125/540-140/540-170: 29kph. Optional 33kph transmission.

Travel speed 540-180/540-200: 29kph.

BRAKING

Service brake: Servo-assisted, hydraulically oil-immersed multi-disc on front and rear axle.

Parking brake: Hand operated disc brake on output of gearbox. (93kW/125hp – oil immersed disc type).

CAB

Conforms to ROPS ISO 3471 and FOPS ISO 3449

OPTIONS

Front and rear working lights, rotating flashing beacon, fire extinguisher, traction and industrial tyres, electrical 2/4WD select, limited slip differential in front axle, windscreen and roof guard, air suspension seat, deluxe cab trim, roof and front screen blind, radio kit, air conditioning, reversing fan, deluxe trim, armrest (SLC only), roof moulding.

Single lever mechanical joystick, with push button extend and retract.

Single lever servo joystick option on 535-125, 540-140 & 540-180.

Options of rear or rear & offside reversing cameras with the extra option to add pulse radar all with dash mounted screen.

Centralised greasing available on the 540-180 HiViz.