

STATIC DIMENSIONS

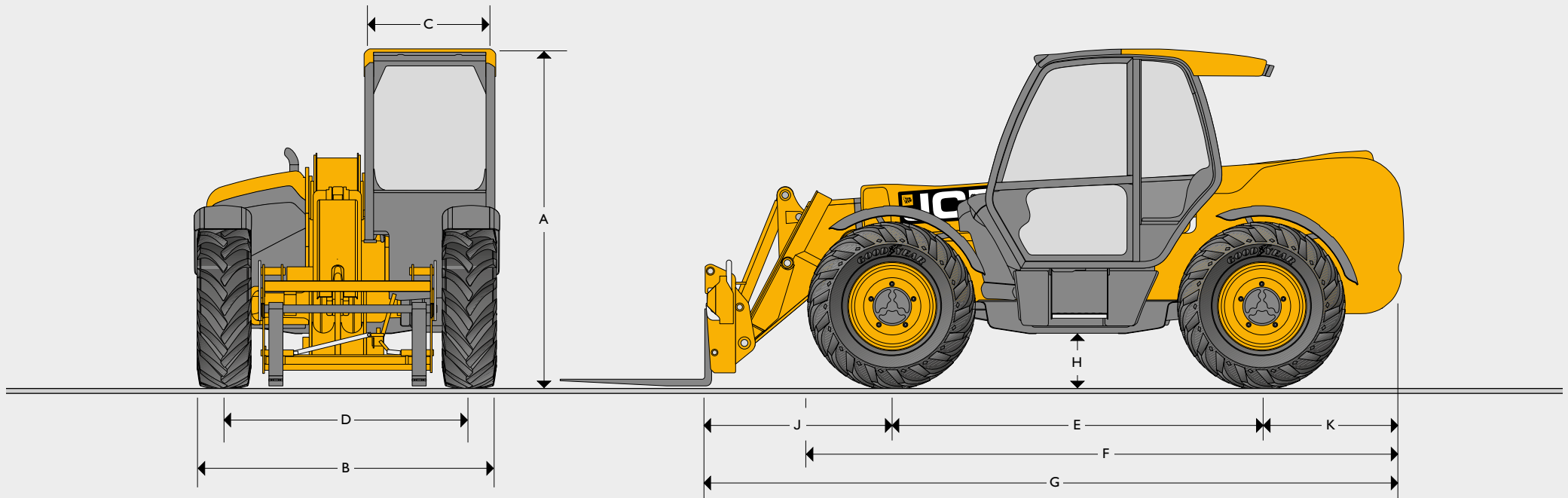

STATIC DIMENSIONS

Machine model		531-70	541-70	535-95	533-105	535-125 HiViz	540-140 HiViz	540-170	540-180 HiViz	540-200
A Overall height	m	2.49	2.49	2.49	2.49	2.59	2.59	2.69	2.59	2.72
B Overall width (over tyres)*	m	2.23	2.23	2.36	2.36	2.35	2.35	2.44	2.35	2.44
C Inside width of cab	m	0.94	0.94	0.94	0.94	0.94	0.94	0.94	0.94	0.94
D Front track	m	1.81	1.81	1.87	1.87	1.90	1.90	1.90	1.90	1.97
E Wheelbase	m	2.75	2.75	2.75	2.75	2.75	2.75	2.75	2.75	2.75
F Overall length to front tyres	m	4.38	4.38	4.38	4.38	4.74	4.74	5.08	4.75	5.09
G Overall length to front carriage	m	4.99	4.99	4.99	5.38	5.80	6.23	6.36	6.27	6.81
H Ground clearance	m	0.40	0.40	0.40	0.40	0.40	0.40	0.40	0.40	0.41
J Front wheel centre to carriage	m	1.25	1.25	1.20	1.62	1.68	2.11	1.94	2.15	2.39
K Rear wheel centre to rear face	m	0.99	0.99	1.04	1.01	1.37	1.37	1.67	1.37	1.67
Overall width with stabilisers fully deployed	m	NA	NA	NA	2.63	2.57	2.57	3.55	3.39	3.82
Outside turn radius (over tyres)	m	3.7	3.7	3.7	3.7	3.75	3.75	4.1	3.75	4.1
Carriage rollback angle	degrees	42.6	42.6	41.0	41.2	37.0	37.0	39	36.5	39
Carriage dump angle	degrees	37.5	37.5	24.0	24.0	12.5	12.5	8.8	12.5	8.8
Weight	kg	7060	7850	8215	8850	10066	10880	12060	11380	12985
Tyres		400/80 - 24	400/80 - 24	400/80 - 24	400/80 - 24	400/80 - 24	400/80 - 24	440/80 - 24	400/80 - 24	440/80 - 24

\* Type dependent

LIFT PERFORMANCE

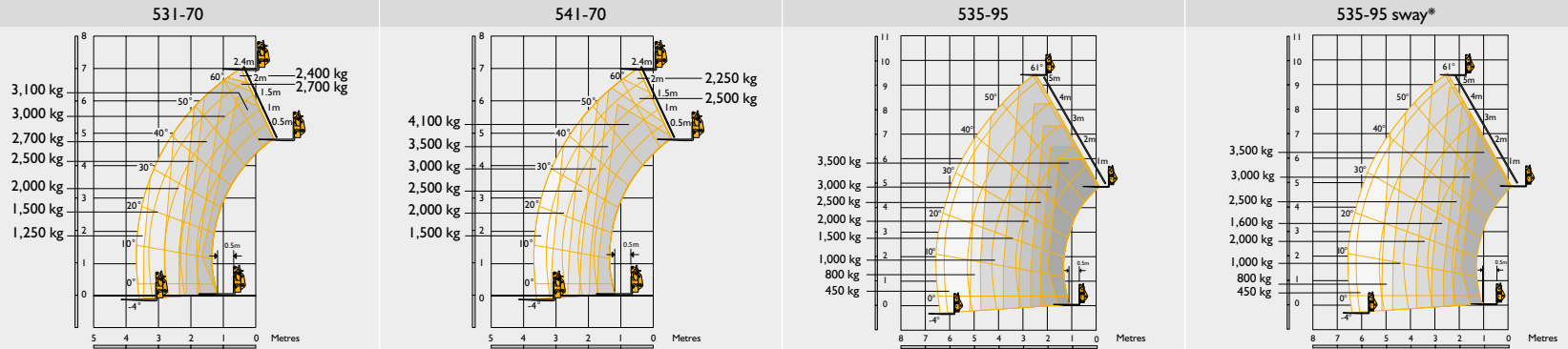

Maximum lift capacity	kg	3100	4100	3500	3500
Lift capacity to full height	kg	2400	2250	1500	1600
Lift capacity at full reach	kg	1250	1500	450	450
Lift height	m	7.0	7.0	9.50	9.50
Reach at maximum lift height	m	0.54	0.54	2.49	2.49
Maximum forward reach	m	3.7	3.7	6.52	6.52
Reach with 1 tonne load	m	3.7	3.7	4.73	4.73
Placing height	m	6.3	6.3	8.78	8.78

Complies with stability test EN 1459 Annex B. chassis levelling (sway) with stabilisers retracted (sway angle ±9°).

LIFT PERFORMANCE

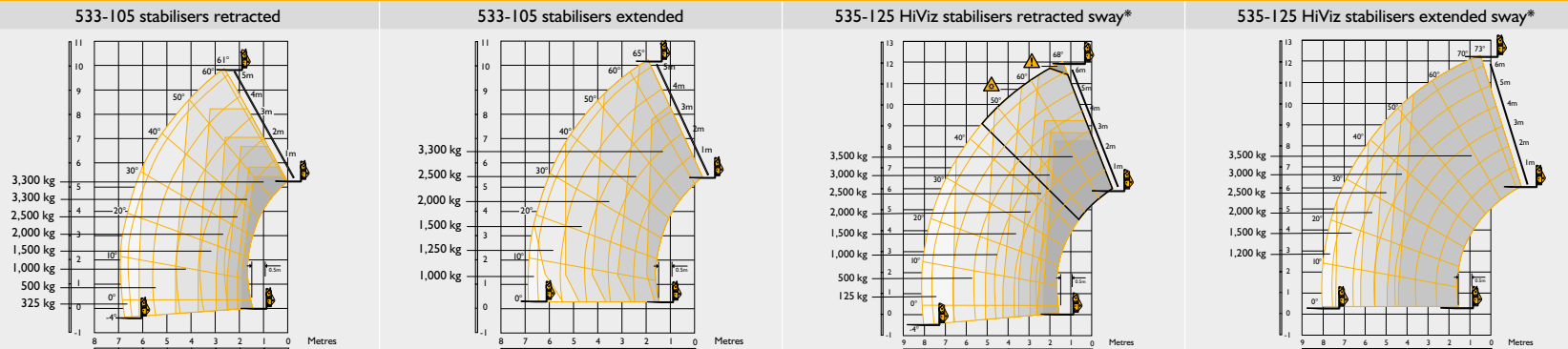

Maximum lift capacity	kg	3300	3300	3500	3500
Lift capacity to full height	kg	1000	2500	1500	3500
Lift capacity at full reach	kg	325	1000	125	1200
Lift height	m	9.85	10.22	11.7	12.27
Reach at maximum lift height	m	2.69	1.99	2.01	0.54
Maximum forward reach	m	6.94	6.83	8.06	8.06
Reach with 1 tonne load	m	4.65	6.83	5.06	8.06
Placing height	m	9.44	9.82	11	11.75

Complies with stability test EN 1459 Annex B. chassis levelling (sway) with stabilisers retracted (sway angle ±9°).

\* Sway levelling is optional, performance may vary when not fitted.

▲ Standard machine software interlock - 45° boom angle limit, configurable upon service request.

LIFT PERFORMANCE

540-140 HiViz stabilisers retracted sway\*

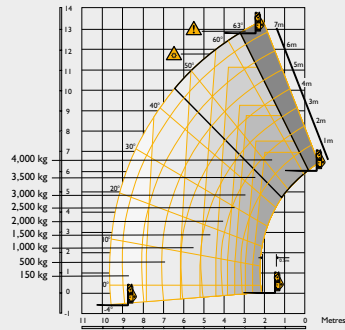

540-140 HiViz stabilisers extended sway\*

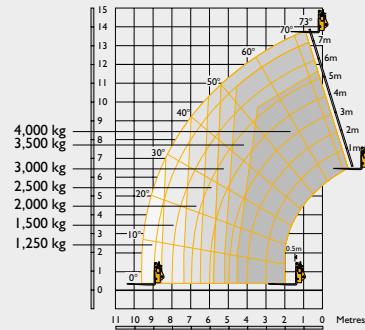

540-170 stabilisers retracted sway

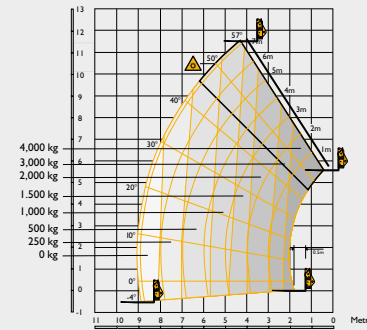

540-170 stabilisers extended sway

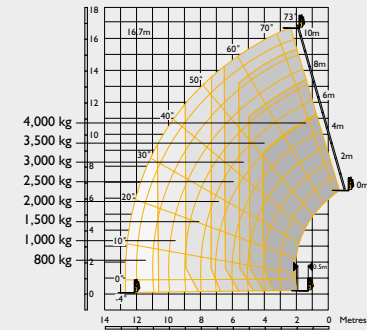

Maximum lift capacity	kg	4000	4000	4000	4000
Lift capacity to full height	kg	1500	3000	1000	2500
Lift capacity at full reach	kg	150	1250	0	800
Lift height	m	12.89	13.78	11.57	16.7
Reach at maximum lift height	m	3.09	1.01	4.32	1.97
Maximum forward reach	m	9.70	9.64	9.04	12.50
Reach with 1 tonne load	m	6.08	9.64	5.68	11.70
Placing height	m	12.40	13.30	10.90	16.20

Complies with stability test EN 1459 Annex B. chassis levelling (sway) with stabilisers retracted (sway angle  $\pm 9^\circ$ ).

LIFT PERFORMANCE

540-180 HiViz stabilisers retracted sway

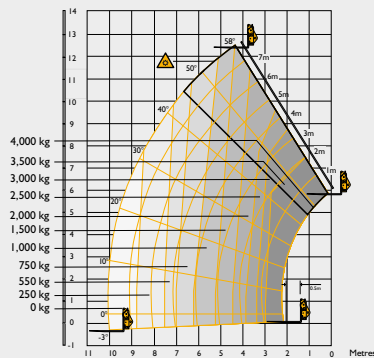

540-180 HiViz stabilisers extended sway

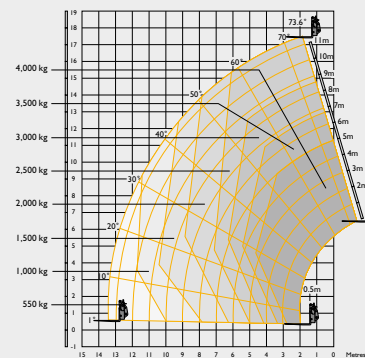

540-200 stabilisers retracted sway

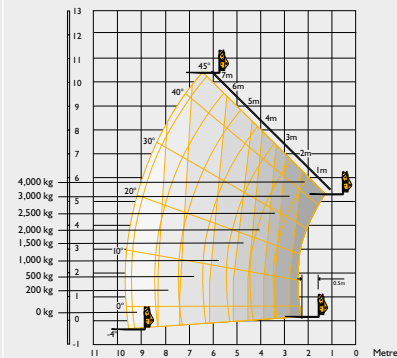

540-200 stabilisers extended sway

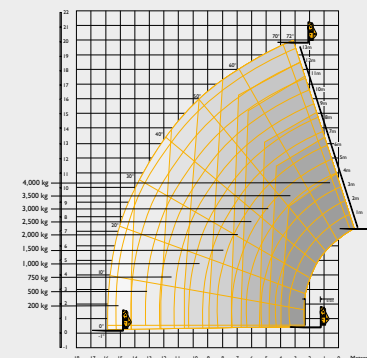

Maximum lift capacity	kg	4000	4000	4000	4000
Lift capacity to full height	kg	500	2500	500	1500
Lift capacity at full reach	kg	0	550	0	200
Lift height	m	12.54	17.51	10.27	20
Reach at maximum lift height	m	5.9	1.88	6.42	2.82
Maximum forward reach	m	10.10	13.34	9.63	15.9
Reach with 1 tonne load	m	6.22	11.72	6.25	10.65
Placing height	m	12.0	17.0	9.1	19.1

Complies with stability test EN 1459 Annex B. chassis levelling (sway) with stabilisers retracted (sway angle  $\pm 9^\circ$ ).

\*Sway levelling is optional, performance may vary when not fitted.

▲ Standard machine software interlock - 45° boom angle limit, configurable upon service request.

LIFT PERFORMANCE

540-140 HiViz 1000kg, 180° slewing man platform, stabilisers extended

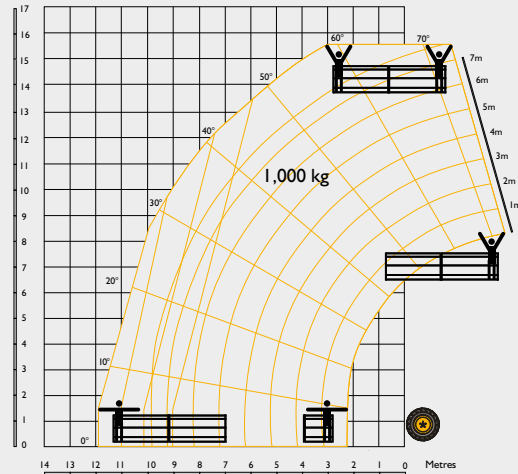

540-180 HiViz 1000kg, 180° slewing man platform, stabilisers extended

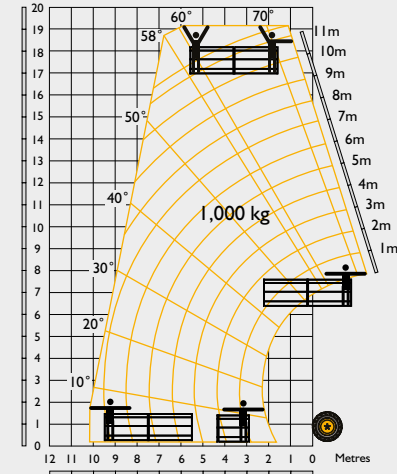

Platform capacity option		365kg platform	500kg platform	1000kg platform	365kg platform	500kg platform	1000kg platform
Machine capacity	kg	4000	4000	4000	4000	4000	4000
Platform rated capacity	kg	365	500	1000	365	500	1000
Type (fixed / slewing)		Fixed	Slewing - 180°	Slewing - 180°	Fixed	Slewing - 180°	Slewing - 180°
Capacity to full working height	kg	365	500	1000	365	500	1000
Capacity at full reach	kg	365	150	150	365	150	150
Maximum forward reach (slewed platform)	m	11.1	12.21	11.85	13.85	13.16	12.5
Personnel work height	m	15.6	15.6	15.6	19.25	19.25	19.25

\*1000kg basket requires rear run flat tyres to be fitted

POINT LOADS

At maximum machine lift capacity (i.e. 4 tonne on a 540-170)

		531-70	541-70	535-95	533-105	535-125 HiViz	540-140 HiViz	540-170	540-180 HiViz	540-200
Load per front wheel	kg	4731	5616	5540	5565	6365	6880	7541	6560	7723
Load per rear wheel	kg	441	480	440	476	415	415	610	1131	730
Load per stabiliser	kg	N/A	N/A	N/A	4188	5151	6010	5824	6243	5760

With no load on the forks and boom retracted in travel position

Load per front wheel	kg	1803	1847	1957	2312	2499	2484	2694	2608	2992
Load per rear wheel	kg	1819	2200	2273	2078	2530	3060	3457	3462	3462

## ENGINE

## JCB 430 DieselMAX Stage V, 3 litre, 4 cylinder, turbo charged

	531-70	541-70	535-95	533-105	535-125 HiViz	540-140 HiViz	540-170	540-180 HiViz	540-200
Engine 55kW (74hp) @ 2200rpm, 440Nm torque at 1300rpm	Standard	N/A	Standard	Standard	Standard	Standard	Standard	Standard	Standard

## JCB 448 DieselMAX Stage V, 4.8 litre, 4 cylinder, turbo charged

	531-70	541-70	535-95	533-105	535-125 HiViz	540-140 HiViz	540-170	540-180 HiViz	540-200
Engine 81kW (109hp) @ 2200rpm, 516Nm torque at 1300rpm	Option	Standard	Option	Option	Option	Option	Option	Option	Option

## HYDRAULIC CYCLE TIMES

	531-70	541-70	535-95	533-105	535-125 HiViz	540-140 HiViz	540-170	540-180 HiViz	540-200
Boom raise s	7.2	8.8	9.1	8.8	10.4	13.5	22.7	13.8	17.3
Boom lower s	5.4	6.5	7.7	8.5	8.1	11	23.4	10.2	15.9
Extend s	6.8	6.8	10.5	13.2	15.7	15.6	18.3	22.4	28.1
Retract s	5	5	11.2	13.6	12.8	14.4	16.7	17.9	22.7
Bucket dump s	3.5	3.5	2.4	2.4	2.9	2.9	4.2	2.9	6.1
Bucket crowd s	2.9	2.9	3.5	3.4	2.6	2.6	4.6	2.6	5.9

## HYDRAULICS

	Hydraulic System Pressure (bar)	Max. Pump flow (litres)
531-70	240	82
541-70	260	82
535-95	240	82
533-105	240	82
535-125	260	110
540-140	260	110
540-170	260	170
540-180	260	110
540-200	260	110

## NOISE AND VIBRATION

	55kW	81kW	93kW	Uncertainty	Measurement conditions.
Noise at the operator station LpA	77	80	81	+/- 1 dB	Determined in accordance with the test method defined in EN12053.
Noise emission from the machine LWA	104	106	107	+/- 1 dB	Guaranteed equivalent sound power (external noise) determined in accordance with the dynamic test conditions defined in 2000/14/EC.
Hand-arm vibration m/s <sup>2</sup>	<2.5	<2.5	<2.5	N/A	ISO 5349-2:2001 dynamic test conditions.

## TRANSMISSION

Torque converter, 4 speed powershift gearbox.

**Travel speed 531-70, 541-70, 535-95, 533-105:** 29kph, 33kph (when 2/4WD select is specified).

**Travel speed 535-125, 540-140, 540-180:** 29kph. Optional 33kph transmission.

**Travel speed 540-170, 540-200:** 29kph.

## BRAKING

**531-70, 541-70, 535-95, 533-105:**

**Servo-assisted:** Front axle, oil-immersed multi-disc, automatic 4-wheel drive braking

**Parking brake:** Hand operated disc brake on gearbox output.

**535-125, 540-140, 540-170, 540-180, 540-200:**

**Servo-assisted:** Front and Rear axle, oil immersed multi-disc, automatic 4-wheel drive braking

**Parking Brake:** Hand operated disc brake on gearbox output.

## CAB

Conforms to ROPS ISO 3471 and FOPS ISO 3449

## OPTIONS

Front and rear working lights, rotating flashing beacon, fire extinguisher, traction and industrial tyres, electrical 2/4WD select, limited slip differential in front axle, windscreen and roof guard, air suspension seat, deluxe cab trim, roof and front screen blind, radio kit, air conditioning, reversing fan, deluxe trim, armrest (SLC only), roof moulding.

Single lever mechanical joystick, with push button extend and retract.

Single lever servo joystick option on 535-125, 540-140, 540-170, 540-180 & 540-200.

Options of rear or rear & offside reversing cameras.

Centralised greasing available on the 540-180 HiViz.